



ZLAC8015

Servo Driver Manual (Special for Hub Servo Motor)

【 Please read the manual in detail before use, to avoid damage to the driver】

Shenzhen ZhongLing Technology Co.,Ltd.

Add: 8th Floor, Building 3, Qiyu Industrial City, Gongle Tiezai Rd., Xixiang St., Bao'an Dist, Shenzhen, China

Postcode: 518102

Tel: +86-0755-2979 9302

Fax: +86-0755-2912 4283

Email: sales@zlingkj.com

Web: www.zlingkj.com



CONTENTS

| | |
|---|----|
| RELEASE NOTES | 2 |
| PREFACE..... | 3 |
| SAFETY PRECAUTIONS..... | 3 |
| 1. PRODUCT INTRODUCTION | 6 |
| 1.1. OUTLINE | 6 |
| 1.2. FEATURES | 6 |
| 1.3. APPLICATION | 6 |
| 2. ELECTRICAL, ENVIRONMENTAL INDEX..... | 7 |
| 2.1. ELECTRICAL INDEX..... | 7 |
| 2.2. ENVIROMENTAL INDEX..... | 7 |
| 2.3. INSTALLATION DIMENSION | 7 |
| 2.4. INSTALLATION..... | 8 |
| 3. DRIVER INTERFACE AND WIRING..... | 9 |
| 3.1. INTERFACE DEFINITION | 9 |
| 3.2 CONTROL SIGNAL WIRING | 11 |
| 3.3. CANOPEN COMMUNICATION PORT DESCRIPTION | 13 |
| 3.4. RS485 COMMUNICATION PORT DESCRIPTION..... | 13 |
| 3.5. STATUS INDICATOR LED..... | 13 |
| 4. DIP SWITCH SETTINGS | 14 |
| 4.1. STEP RESOLUTION SETTINGS | 14 |
| 4.2 TERMINAL RESISTANCE SETTINGS | 15 |

RELEASE NOTES

| Version | Update Time | Update Content | Updater |
|---------|-------------|----------------|---------|
| V1.0 | 2019-12-28 | First Edition | LHY |

PREFACE

Thanks for choosing ZLAC8015, the servo driver for hub servo motor.

This manual describes the installation, debugging, maintenance, operation and other aspects of the servo driver ZLAC8015. Please read this manual in detail before use, and be familiar with the safety precautions.

This manual may be revised timely when product is improved, specification and version are changed or for some other reasons, which will not be notified particularly.

Any questions when using our products, please read the relevant manual or call our technical service department, we will meet your requirements in the shortest possible time.

Marks and warning signal:



Danger: Indicates that this operation error may endanger personal safety!



Attention: Indicates that this operation error may result in equipment damage!

SAFETY PRECAUTIONS

Open Box and Check



Do not install integrated step-servo motor which is damaged or with missing parts.

Installation



Installed on a non-flammable metal frame, prevent the intrusion of

dust, corrosive gases, conductive objects, liquids and flammable materials, and maintain good heat dissipation conditions.



During installation, be sure to tighten the mounting screws of the integrated step-servo motor. It should be protected from vibration and shock.

Wiring



Please perform the wiring work by professional electrical engineer;



Before wiring, please confirm that the input power is off. Wiring and inspection must be performed after the power is turned off and the integrated step-servo motor indicator is off to prevent electric shock;



When plugging and unplugging the integrated step-servo motor terminals, make sure that its indicator is off before proceeding;



Please set the emergent stop circuit outside the controller;



Please tighten the output terminal with a suitable torque.

Electrify



Please confirm whether the main circuit input power is consistent with the rated working voltage of the integrated step-servo motor;



Do not test the integrated step-servo motor for high voltage and insulation resistance at will;



Do not connect the electromagnetic contactor or electromagnetic switch to the output circuit.

Operation





Do not directly touch the output terminals after the integrated step-servo motor is powered on;



When the system is running, the integrated step-servo motor may

have a high temperature rise, do not touch it;

 Please confirm the input and output signals to ensure safe operation;

 The alarm can be reset only after the operation signal is cut off. Alarm

resetting in the running signal state will cause the integrated step-servo motor to restart suddenly;

 Do not change the parameter settings of the integrated step-servo

motor at will. The parameter modification needs to be performed under standby condition.

Maintenance and Inspection

 Do not touch the integrated step-servo motor terminals directly, and some have high voltage, very dangerous;

 Before powering up, be sure to install the cover; when removing the cover, be sure to cut off the power supply first;

 Before wiring, please confirm whether the input power is off;

 After cutting off the main circuit input power and confirming the integrated step-servo motor indicator light has completely extinguished, it can be inspected and maintained;

 Do the inspection and maintenance by professional electrical engineer;

 Do not do wiring, disassembling or other operation on the terminals during power on.

 There is an integrated circuit on the main control board of the servo driver. Please pay full attention when checking to avoid damage caused by static induction.

1. PRODUCT INTRODUCTION

1.1. OUTLINE

ZLAC8015 is a high-performance digital servo driver for hub servo motor. It has a simple structure and high integration, and adds bus communication and single-axis controller function.

1.2. FEATURES

- Adopt CAN bus communication, support CiA301 and CiA402 sub-protocol of CANopen protocol, could mount up to 127 devices. CAN bus communication baud rate defaults to 500Kbps.

- Adopt RS485 bus communication, support modbus-RTU protocol, could mount up to 127 devices. RS485 bus communication baud rate defaults to 115200bps.

- Support operation modes such as position control, velocity control and torque control.

- User can control the start and stop of the motor through bus communication and query the real-time status of the motor.

- Input voltage: 24V-48VDC.

- 2 isolated signal input ports, programmable, implement the driver's functions such as enable, start stop, emergency stop and limit.

- 2 isolated output ports, programmable, output driver's status and control signal.

- With protect function such as over-voltage, over-current.

1.3. APPLICATION

Suitable for AGV, delivery robot, service robot, automated handling machine, etc.

2. ELECTRICAL, ENVIRONMENTAL INDEX

2.1. ELECTRICAL INDEX

| Driver Parameter | Min value | Typical value | Max value | Unit |
|------------------------------|-----------|---------------|-----------|------|
| Input voltage | 20 VDC | 36VDC | 48VDC | V |
| Output current(peak) | 0 | 15 | 30 | A |
| Control signal input current | 7 | 10 | 16 | mA |
| Over-voltage protection | - | 60 | - | VDC |
| Under-voltage protection | - | 16 | - | VDC |
| Input signal voltage | - | 5 | - | VDC |
| Insulation resistance | 100 | | | MΩ |

2.2. ENVIRONMENTAL INDEX

| Cooling Type | | Natural cooling or forced cooling |
|---------------------|-----------------------|--|
| Working environment | Application occasion | Avoid dust, oil mist and corrosive gases |
| | Working temperature | 0~50℃ |
| | Max. ambient humidity | 90% RH(no condensation) |
| | Storage temperature | -10~70℃ |
| | Vibration | 10~55Hz/0.15mm |

2.3. INSTALLATION DIMENSION

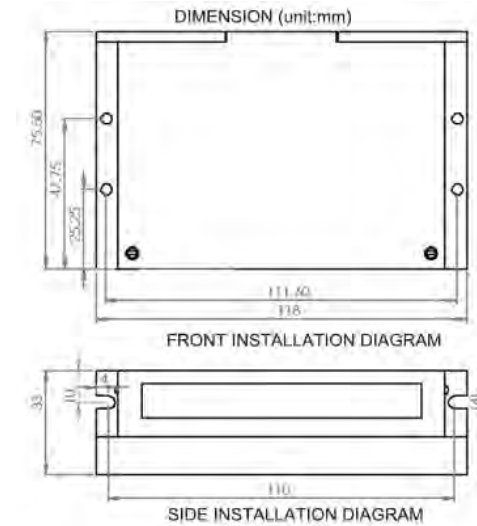

Fig.1 Installation dimension diagram (unit: mm)

2.4. INSTALLATION

User can use the wide or narrow side of the driver cooled radiator for installation. If installing with wide side, use M3 screws to install through the holes on four corners. If installing with narrow side, use M3 screws to install through the holes on both sides. In order to achieve good heat dissipation, it is recommended to use narrow-side installation.

The power device of the driver will generate heat. If it works continuously under the condition of high input voltage and high power, the effective heat dissipation area should be enlarged or forced cooling. Do not use it in a place where there is no air circulation or where the ambient temperature exceeds 60 ° C. Do not install the driver in a humid or metal debris place.

3. DRIVER INTERFACE AND WIRING

3.1. INTERFACE DEFINITION

3.1.1 Power input port

| Port | Pin | Mark | Name | Function | |
|------|-----|------|------------------------|----------------------|-------------------------|
| | 1 | DC | Power supply interface | Power supply 24V-48V | |
| | 2 | GND | | | |
| | 3 | U | Motor power interface | | Wire connected to motor |
| | 4 | V | | | |
| | 5 | W | | | |

3.1.2 Encoder and Hall port

| Port | Pin | Mark | Name | Function | |
|------|-----|------|--------------------|----------|----------------------------|
| | 1 | iA+ | Encoder | | |
| | 2 | iA- | | | |
| | 3 | iB+ | | | |
| | 4 | iB- | | | |
| | 5 | RTC+ | temperature sensor | | |
| | 6 | RTC- | | | |
| | 7 | V | Hall sensor | | |
| | 8 | W | | | |
| | 9 | U | | | |
| | 10 | GND | Power ground | | |
| | 11 | VCC | Power positive | | Output to encoder and HALL |
| | 12 | GND | Power ground | | |

3.1.3 Control signal port

| Port | Pin | Mark | Name | Function |
|------|-----|-------|---------------------------------|--|
| | 1 | B- | Brake- | Brake control (5-24V) |
| | 2 | BGND | External power ground | |
| | 3 | BDC | Brake+, External power positive | |
| | 4 | | | |
| | 5 | IN1+ | Input 1 | Could be edited via CANOPEN or 485 |
| | 6 | IN1- | | |
| | 7 | IN2+ | Input 2 | |
| | 8 | IN2- | | |
| | 9 | OUT1+ | Output | Could be edited via CANOPEN or 485 |
| | 10 | OUT1- | | |
| | 11 | oB+ | Encoder output | |
| | 12 | oB- | | |
| | 13 | oA+ | | |
| | 14 | oA- | | |
| | 15 | 5V | 5V OUT | Could be used to supply power for IN or OUT port, output current cannot exceed 100mA |
| | 16 | GND | GND | |

3.1.4 DIP switch

| Port | Pin | Mark | Name | Function |
|------|-----|------|------------|---|
| | 1 | SW1 | DIP switch | CANOPEN termination resistance selection |
| | 2 | SW2 | | RS485 termination resistance selection |
| | 3 | SW3 | | CANOPEN address selection is 1-3. When it is 0, it can be set to 4-127 by software. |
| | 4 | SW4 | | |
| | 5 | SW5 | | RS485 address selection is 1-3. When it is 0, it can be set to 4-127 by software. |
| | 6 | SW6 | | |

3.1.5 Communication port

| Port | Pin | Mark | Name | Function |
|------|-----|------|---------|----------|
| | 1 | CANH | CANOPEN | |
| | 3 | CANL | | |
| | 2 | A | RS485 | |
| | 4 | B | | |
| | 5 | CANH | CANOPEN | |
| | 7 | CANL | | |
| | 6 | A | RS485 | |
| | 8 | B | | |

3.2 CONTROL SIGNAL WIRING

ZLAC8015 series driver provides 2 photoelectric isolation programmable input interfaces, compatible with NPN wiring and PNP wiring.

2-channel (IN1-IN2) programmable input signal is isolated from the external control

interface by an optocoupler. The driver is compatible with common cathode and common anode connections, as shown in the following Figure 2. In order to ensure the reliable conduction of the optocoupler inside the driver, the drive current provided by the controller must be at least 10mA.

The level pulse width of IN1-IN2 input needs to be bigger than 10ms, otherwise the driver may not respond normally. The IN1-IN2 timing diagram is shown in Figure 3.

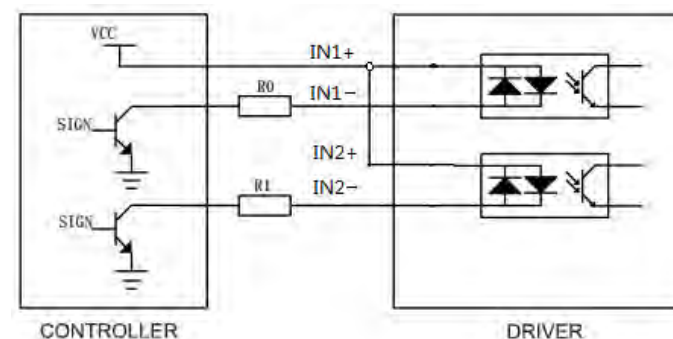

Fig.2 Input interface circuit

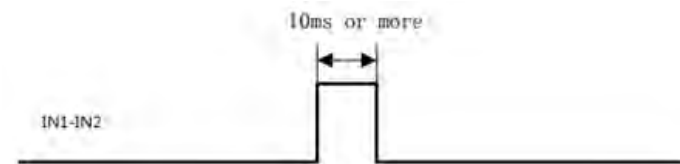

Fig.3 Control signal interface wiring diagram



Note: The default input voltage of the control signal is 5V. For other voltages, current limiting resistors must be added, for example: 12V, external 1K 1 / 2W resistor; 24V, external 2K 1 / 2W resistor.

After the driver is powered on, IN1-IN2 defaults to the unspecified state. At this time, the input signal is invalid. User could configure IN1-IN2 input functions through bus

communication.

ZLAC8015 series driver provides 2 photoelectric isolated output terminals, supports both of NPN and PNP wiring methods, and also supports high-level and low-level active controllers.

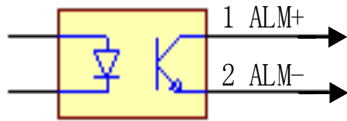

3.3. CANOPEN COMMUNICATION PORT DESCRIPTION

ZLAC8015 series driver provides 4PIN communication port. For pin definition, please refer to 3.1.5 Communication Port, which includes CANH, CANL, CANH and CANL.

Note: Please use shielded twisted-pair cables for communication cable and make ground connection to ensure stable communication.

3.4. RS485 COMMUNICATION PORT DESCRIPTION

ZLAC8015 series driver provides 4PIN communication port. For pin definition, please refer to 3.1.5 Communication Port, which includes A, B, and A, B.

Note: Please use shielded twisted-pair cables for communication cable and make ground connection to ensure stable communication.

3.5. STATUS INDICATOR LED

The green LED is power indicator, which is always on when the driver is powered on; It is off when the driver is powered off. The red LED is fault indicator. When the driver fails, the driver will stop and prompt the corresponding fault code. The fault can be cleared when the user powers off and restarts the power. The status indicator LED represents different operation and fault information, as shown in the following table:

| Status | Situation | Status indicator LED description | |
|---------------------------|--|----------------------------------|-------------|
| | | Count | Pattern |
| Over-Voltage | The power supply voltage exceeds the maximum rated voltage. | 1 Red | ● |
| Under-Voltage | The power supply voltage is lower than the minimum working voltage. | 2 Red | ●● |
| Over-Current | Phase current through the motor exceeds short-circuit between phases | 3 Red | ●●● |
| Over-Load | The phase current through the motor exceeds the set overload current | 4 Red | ●●●● |
| Current out-of-tolerance | Control current and output current are out of tolerance | 5 Red | ●●●●● |
| Position out-of-tolerance | The given position is out of tolerance with the output position | 6 Red | ●●●●●● |
| Speed out-of-tolerance | The given speed and output speed are out of tolerance | 7 Red | ●●●●●●● |
| Internal reference error | Internal fault of the driver | 8 Red | ●●●●●●●● |
| Parameter reading error | EEPROM parameters read error | 9 Red | ●●●●●●●●● |
| HALL fault | The HALL cable is not plugged in or the signal is incorrect | 10 Red | ●●●●●●●●●● |
| High motor temperature | Motor temperature is too high | 11 Red | ●●●●●●●●●●● |

4. DIP SWITCH SETTING

ZLAC8015 driver uses a 6-digit DIP switch to set the terminal resistance and driver address. The details are as follows:

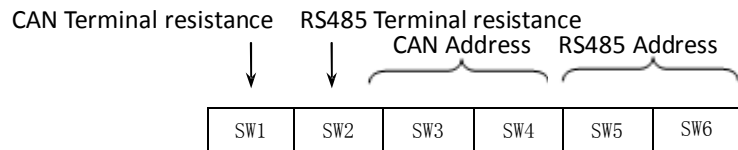

4.1. STEP RESOLUTION SETTINGS

A. CAN Address

| SW3 | SW4 | Address |
|-----|-----|---------|
| OFF | OFF | Custom |
| ON | OFF | 1 |
| OFF | ON | 2 |
| ON | ON | 3 |

B. RS485 Address

| SW5 | SW6 | Address |
|-----|-----|---------|
| OFF | OFF | Custom |
| ON | OFF | 1 |
| OFF | ON | 2 |
| ON | ON | 3 |

User could use CANOPEN/RS485 bus to control up to 127 ZLAC8015 series drivers at the same time. The driver communication address is set with a 4-digit DIP switch. The address setting range is 1-3, where address 0 needs to be set and saved by the driver software. SW3-SW4(SW5-SW6) switches must be all set to ON.

4.2. TERMINAL RESISTANCE SETTING

User can select whether to incorporate a 120 Ω-terminal resistor through this bit. According to the application, it is generally determined that only the master terminal and the last slave need to connect a 120 Ω terminal resistor.

CAN:

SW1 = OFF, invalid;

SW1 = ON, effective.

RS485:

SW2 = OFF, invalid;

SW2 = ON, effective.